

Chancellor

3 RAIL TUBULAR IRON SERIES, STYLE LF-C03

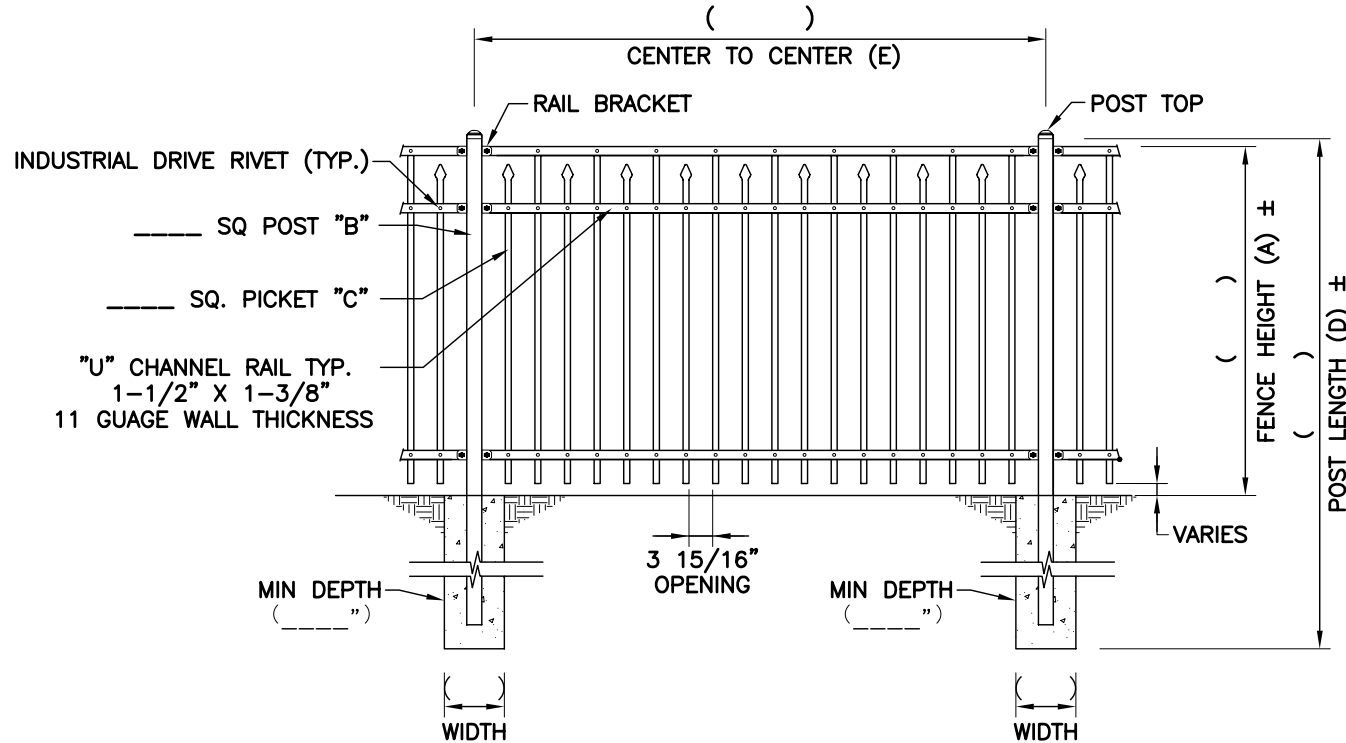





FENCE SECTION ELEVATION
SCALE : NONE

NOTES:

1. DRAWINGS ARE NOT TO SCALE.
2. FOOTING WIDTH TO BE FOUR(4) TIMES THE POST WIDTH.
3. PICKETS SHALL BE SECURED TO RAILS WITH 1/4" ALUMINUM INDUSTRIAL DRIVE RIVETS.
4. MAXIMUM RAKE APPROXIMATELY SIX(6) INCHES.

PICKET TOP OPTIONS

BALL	SPEAR
	
FLAT CAP W/ PLUG	PRESSED POINT
	

POST TOP OPTIONS

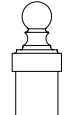
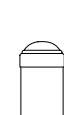
BALL	FLAT
	

PICKET OPTION (C)

3/4" SQ	>	18 GA
OR		16 GA
1" SQ		14 GA

A	___"	NOM HEIGHT
B	___"	POST SIZE ___ GAUGE
C	___"	PICKET SIZE ___ GAUGE
D	___"	POST LENGTH
E	___"	CENTER TO CENTER

POST OPTION (B)

2" SQ X 14 GA
2 1/2" SQ X 14 GA
3" SQ X 12 GA
4" SQ X 11 GA
6" SQ X 3/16" WALL
8" SQ X 1/4" WALL
10" SQ X 1/4" WALL

NOMINAL HEIGHT (A)

3'-0"
3'-6"
4'-0"
5'-0"
6'-0"
7'-0"
8'-0"

CAD #:	MAP
DRAWN BY:	
CKD. BY:	
DATE:	
SCALE:	NONE
SHEET NO.:	

PROJECT NO.:	
PROJECT MANAGER:	

LONG FENCE
www.longfence.com
8545 EDGEWORTH DRIVE
CAPITOL HEIGHTS, MD. 20743
(301) 350-2400
6837

PROJECT	
DRAWING TITLE	FENCE DETAIL

SITE:	
-------	--

Chancellor

4 RAIL TUBULAR IRON SERIES, STYLE LF-C04

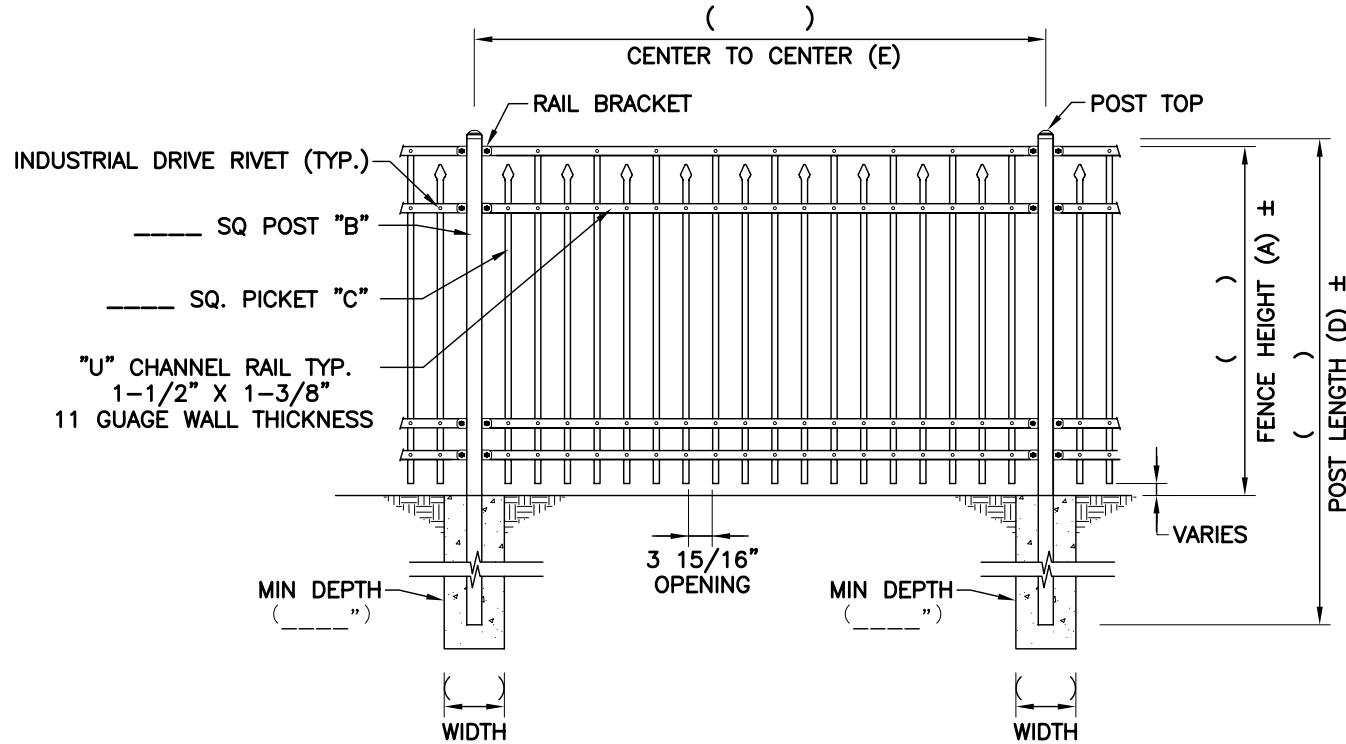





FENCE SECTION ELEVATION
SCALE : NONE

NOTES:

1. DRAWINGS ARE NOT TO SCALE.
2. FOOTING WIDTH TO BE FOUR(4) TIMES THE POST WIDTH.
3. PICKETS SHALL BE SECURED TO RAILS WITH 1/4" ALUMINUM INDUSTRIAL DRIVE RIVETS.
4. MAXIMUM RAKE APPROXIMATELY SIX(6) INCHES.

PICKET TOP OPTIONS

BALL	SPEAR
	
FLAT CAP	PRESSED POINT
	

POST TOP OPTIONS

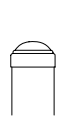
BALL	FLAT
	

PICKET OPTION (C)

3/4" SQ	}	18 GA
OR		16 GA
1" SQ		14 GA

- A ____" NOM HEIGHT
- B ____" POST SIZE ____ GAUGE
- C ____" PICKET SIZE ____ GAUGE
- D ____" POST LENGTH
- E ____" CENTER TO CENTER

POST OPTION (B)	NOMINAL HEIGHT (A)
2" SQ X 14 GA	3'-0"
2 1/2" SQ X 14 GA	3'-6"
3" SQ X 12 GA	4'-0"
4" SQ X 11 GA	5'-0"
6" SQ X 3/16" WALL	6'-0"
8" SQ X 1/4" WALL	7'-0"
10" SQ X 1/4" WALL	8'-0"

CAD #:	MAP
DRAWN BY:	
CHKD. BY:	
DATE:	
SCALE:	NONE
SHEET NO.:	

PROJECT NO.:	
PROJECT MANAGER:	

LONG FENCE
www.longfence.com
8545 EDGEWORTH DRIVE
CAPITOL HEIGHTS, MD, 20743
(301) 350-2400
6837

PROJECT:	
DRAWING TITLE:	FENCE DETAIL

SITE:	
-------	--